

Modelling of Subzero II

Z. Feng and R. Allen

ISVR Technical Memorandum 880

October 2001



SCIENTIFIC PUBLICATIONS BY THE ISVR

Technical Reports are published to promote timely dissemination of research results by ISVR personnel. This medium permits more detailed presentation than is usually acceptable for scientific journals. Responsibility for both the content and any opinions expressed rests entirely with the author(s).

Technical Memoranda are produced to enable the early or preliminary release of information by ISVR personnel where such release is deemed to be appropriate. Information contained in these memoranda may be incomplete, or form part of a continuing programme; this should be borne in mind when using or quoting from these documents.

Contract Reports are produced to record the results of scientific work carried out for sponsors, under contract. The ISVR treats these reports as confidential to sponsors and does not make them available for general circulation. Individual sponsors may, however, authorize subsequent release of the material.

COPYRIGHT NOTICE

(c) ISVR University of Southampton All rights reserved.

ISVR authorises you to view and download the Materials at this Web site ("Site") only for your personal, non-commercial use. This authorization is not a transfer of title in the Materials and copies of the Materials and is subject to the following restrictions: 1) you must retain, on all copies of the Materials downloaded, all copyright and other proprietary notices contained in the Materials; 2) you may not modify the Materials in any way or reproduce or publicly display, perform, or distribute or otherwise use them for any public or commercial purpose; and 3) you must not transfer the Materials to any other person unless you give them notice of, and they agree to accept, the obligations arising under these terms and conditions of use. You agree to abide by all additional restrictions displayed on the Site as it may be updated from time to time. This Site, including all Materials, is protected by worldwide copyright laws and treaty provisions. You agree to comply with all copyright laws worldwide in your use of this Site and to prevent any unauthorised copying of the Materials.

UNIVERSITY OF SOUTHAMPTON
INSTITUTE OF SOUND AND VIBRATION RESEARCH
SIGNAL PROCESSING & CONTROL GROUP

Modelling of Subzero II

by

Z Feng and R Allen

ISVR Technical Memorandum N°880

October 2001

Authorised for issue by
Prof S J Elliott
Group Chairman

Contents

1 Introduction.....	3
2 Nonlinear Equations of Motion and its Simulink Implementation.....	4
2.1 Full nonlinear equations of motion.....	4
2.2 Simulink® model.....	7
3 Thruster Model.....	8
3.1 PWM DC motor model.....	8
3.2 Propeller model.....	8
3.3 Thruster model.....	9
4 Rudder and Sternplane Actuator Models.....	10
5 Full Nonlinear Model of Subzero II.....	10
5.1 Simulink® model.....	10
5.2 Simulation results.....	11
6 Linearized model.....	15
6.1 Linearized model.....	15
6.2 A linearized model of Subzero II.....	15
7 Summary.....	18
References.....	19

1 Introduction

The original Subzero vehicle was built by five Master of Engineering students in 1992 as their group design project for the course [1]. The specification was for a 1m long vehicle with a maximum diameter of 10 cm. The payload carried would be a maximum of 3 kg with a target speed of 0 to 8 knots (approximately 0 to 4 m/s) and depth capability of 6 meters. The duration of a mission was to be 15 minutes. The vehicle has since evolved into Subzero II (shown in Fig 1) as it required considerable redesign and enhancement to allow controller testing [2].



Fig 1 Subzero II

The thruster system consists of the propeller, which is linked to a DC motor and gear box by a steel shaft with a universal coupling. The DC motor is controlled by a pulse width modulated (PWM) drive running at 800 Hz.

On the tail are mounted the four control surfaces: two rudders and two sternplanes. The two rudder surfaces are linked together to form a single rudder.

For H_∞ autopilot design, there will be 3 control subsystems: forward speed control system (driven by thruster), heading control system (driven by rudder) and depth control system (driven by sternplane). In order to verify the H_∞ autopilot at the design stage, a full nonlinear model must be established. Moreover, a linearized plant model must also be established for H_∞ autopilot design.

Based on R.Lea's research work [3,4], we have improved the nonlinear model of Subzero II. Instead of Visual C++, a Simulink[®] model, which is much easier to read and to utilize, has been established.

The model is based on 6 DOF (degree of freedom) nonlinear motion equations Subzero II, and includes the dynamics of the actuators.

It should be noted that the model is currently restricted by the experiment facilities available in the past and the limited testing that could be carried out. The accuracy of the model needs to be improved by further tank tests. At present, some hydrodynamic derivatives are gained from tank tests, while the other coefficients are estimated from the Ocean Voyager (an AUV which is geometrically similar to Subzero II) developed

by Florida Atlantic University who kindly made available model data [4]. The effects of the umbilical are also ignored.

2 Nonlinear Equations of Motion and its Simulink Implementation

2.1 Full Nonlinear Equations of Motion

When analysing the motion of vehicles in 6 DOF it is convenient to define two coordinate frames: the vehicle-fixed frame $O-X_oY_oZ_o$ and the earth-fixed frame $E-\xi\eta\zeta$ as shown in Fig 2. The origin of the vehicle-fixed frame is specified as being at the centre of the hull. The velocity of the vehicle is described as a vector

$$V = [u \ v \ w \ p \ q \ r]^T \quad (1)$$

where u, v, w are translations along, and p, q, r are rotations around the three axes X_o, Y_o, Z_o respectively. The six different motions corresponding to movements in the respective coordinates are surge, sway, heave, roll, pitch and yaw.

The vehicle's position relative to the earth-fixed frame is described as a vector

$$P = [x \ y \ z \ \phi \ \theta \ \psi]^T \quad (2)$$

where x, y, z are the position of the vehicle-fixed frame origin O relative to the earth-fixed frame $E-\xi\eta\zeta$, ϕ, θ, ψ are the attitude angles of the vehicle relative to the earth-fixed frame.

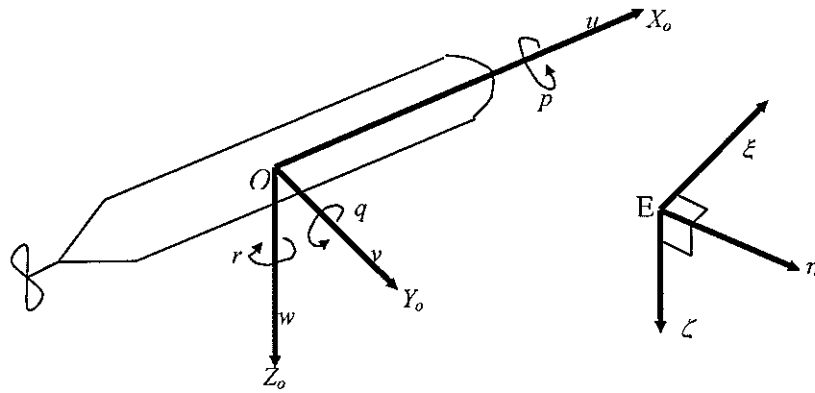

Fig 2 Coordinate systems

Since Subzero II has a torpedo shape, the standard submarine equations of motion from DTNSRDC (David Taylor Naval Ship Research and Development Centre) [5] can be applied to simulate its motion. In nonlinear equations of motion, the rigid body data and the non-dimensional hydrodynamic derivatives of the vehicle are included.

(1) Rigid body data

m —mass of the vehicle (7kg)

ρ --density of the water (1000kg/m³)

l -- length of the vehicle (0.98m)

W --weight of the vehicle (69.0N)

B —buoyancy (69.0N)

(x_G, y_G, z_G) -- position of the vehicle's centre of gravity relative to the

vehicle-fixed frame ($x_G = 0.055m, y_G = 0, z_G = 0.006m$)

(x_B, y_B, z_B) -- position of the vehicle's centre of buoyancy relative to the vehicle-fixed frame ($x_B = 0.055m, y_B = 0, z_B = 0$)

($I_x, I_y, I_z, I_{xy}, I_{yz}, I_{zx}$) -- the moments of inertia around the appropriate axes
($I_x = 0.006kgm^2, I_y = 0.3kgm^2, I_z = 0.3kgm^2, I_{xy} = 0, I_{yz} = 0, I_{zx} = 0.009kgm^2$).

(2) Non-dimensional hydrodynamic derivatives

There are over 60 hydrodynamic derivatives need to be measured. However, restricted by test facilities, only drag coefficients are fitted by the measurements of towing tank tests, i.e.,

$$X'_u = -1.56331 + 1.44963 \cos u + 2.27372 \sin u + 0.71716 \cos 2u - 1.53679 \sin 2u \\ - 0.73919 \cos 3u + 0.09957 \sin 3u + 0.13634 \cos 4u + 0.15798 \sin 4u \\ + 0.00735 \cos 5u - 0.02748 \sin 5u$$

$$Y'_v = -3.68 \times 10^{-2}, Z'_w = -3.68 \times 10^{-2}, X'_{\delta\delta} = X'_{\delta r\delta r} = 4.7 \times 10^{-3}$$

The remaining hydrodynamic derivatives are estimated according to the hydrodynamic derivatives of Ocean Voyager vehicle.

Surge motion equation:

$$(m - \frac{1}{2} \rho l^3 X'_u) \dot{u} + m z_G \dot{q} - m y_G \dot{r} = \frac{1}{2} \rho l^4 [X'_{qq} q^2 + X'_{rr} r^2 + X'_{rp} rp] \\ + \frac{1}{2} \rho l^3 [X'_{vr} vr + X'_{wq} wq] \\ + \frac{1}{2} \rho l^2 [X'_{vv} v^2 + X'_{ww} w^2] \\ + \frac{1}{2} \rho l^2 [X'_{\delta r\delta r} \delta r^2 + X'_{\delta\delta} \delta s^2] u^2 \\ - (W-B) \sin \theta + T - \frac{1}{2} \rho l^2 X'_u u^2 \\ + m [vr - wq + x_G (q^2 + r^2) - y_G qp - z_G rp]$$

where T is the thrust produced by the propeller.

Sway motion equation:

$$(m - \frac{1}{2} \rho l^3 Y'_v) \dot{v} - (m z_G + \frac{1}{2} \rho l^4 Y'_p) \dot{p} + (m x_G - \frac{1}{2} \rho l^4 Y'_r) \dot{r} \\ = \frac{1}{2} \rho l^4 [Y'_{pp} p|p| + Y'_{pq} pq] \\ + \frac{1}{2} \rho l^3 [Y'_{ur} ur + Y'_{up} up + Y'_{wp} wp] \\ + \frac{1}{2} \rho l^2 [Y'_{uu} u^2 + Y'_v uv + Y'_{vv} v \sqrt{v^2 + w^2}] \\ + \frac{1}{2} \rho l^2 Y'_{\delta r} u^2 \delta r \\ + (W-B) \cos \theta \sin \phi \\ + m [wp - ur + y_G (r^2 + p^2) - z_G qr - x_G qp] \\ - \frac{1}{2} \rho C_d \int_{x_{tail}}^{x_{nose}} d(x) (v + xr) \sqrt{(w - xq)^2 + (v + xr)^2} dx$$

where C_d ($=0.9770$) is the sideways drag coefficient of the vehicle and $d(x)$ is the diameter of the vehicle at a distance x from tail to nose.

$$x_{tail} = -0.545 \text{ (m)}, x_{nose} = 0.435 \text{ (m)}$$

$$d(x) = \begin{cases} 0.02 + \frac{8}{11}(x + 0.545), & -0.545 \leq x \leq -0.435 \\ 0.10, & -0.435 \leq x \leq 0.385 \\ 2\sqrt{0.05^2 - (x - 0.385)^2}, & 0.385 \leq x \leq 0.435 \end{cases}$$

Heave motion equation:

$$\begin{aligned} (m - \frac{1}{2}\rho l^3 Z'_w) \dot{w} + m y_G \dot{p} - (m x_G + \frac{1}{2}\rho l^4 Z'_q) \dot{q} &= \frac{1}{2}\rho l^3 [Z'_q uq + Z'_{vp} vp] \\ &+ \frac{1}{2}\rho l^2 [Z'_{uu} u^2 + Z'_w uw] \\ &+ \frac{1}{2}\rho l^2 [Z'_w u|w| + Z'_{ww} |w|\sqrt{v^2 + w^2}] \\ &+ \frac{1}{2}\rho l^2 Z'_{\delta\delta} u^2 \delta s \\ &+ (W - B) \cos \theta \cos \phi \\ &+ m[uq - vp + z_G(p^2 + q^2) - x_G rp - y_G rq] \\ &- \frac{1}{2}\rho C_d \int_{x_{tail}}^{x_{nose}} d(x)(w - xq)\sqrt{(w - xq)^2 + (v + xr)^2} dx \end{aligned} \quad (5)$$

Roll motion equation:

$$\begin{aligned} -(m z_G + \frac{1}{2}\rho l^4 K'_v) \dot{v} + m y_G \dot{w} + (I_x - \frac{1}{2}\rho l^5 K'_p) \dot{p} - I_{xy} \dot{q} - (I_{zx} + \frac{1}{2}\rho l^5 K'_r) \dot{r} \\ = \frac{1}{2}\rho l^5 [K'_{qr} qr + K'_{pp} p|p|] \\ + \frac{1}{2}\rho l^4 [K'_p up + K'_r ur + K'_{wp} wp] \\ + \frac{1}{2}\rho l^3 [K'_{uu} u^2 + K'_{vR} uv] \\ + \frac{1}{2}\rho l^3 K'_{\delta\delta} u^2 \delta r \\ + (y_G W - y_B B) \cos \theta \sin \phi + \frac{1}{2}\rho l^3 K'_{prop} n^2 \\ + m[y_G(uq - vp) - z_G(wp + ur)] \\ - (I_z - I_y)qr + I_{zx}qp - (r^2 - q^2)I_{yz} - I_{xy}pr \end{aligned} \quad (6)$$

Pitch motion equation:

$$\begin{aligned} m z_G \dot{u} - (m x_G + \frac{\rho}{2} l^4 M'_w) \dot{w} - I_{xy} \dot{p} + (I_y - \frac{\rho}{2} l^5 M'_q) \dot{q} - I_{yz} \dot{r} \\ = \frac{\rho}{2} l^5 M'_{rp} rp + \frac{\rho}{2} l^4 M'_q uq \\ + \frac{\rho}{2} l^3 [M'_{uu} u^2 + M'_w uw + M'_{wwR} w\sqrt{v^2 + w^2}] \\ + \frac{\rho}{2} l^3 [M'_w u|w| + M'_{ww} |w|\sqrt{v^2 + w^2}] \\ + \frac{\rho}{2} l^3 M'_{\delta\delta} u^2 \delta s \\ - (x_G W - x_B B) \cos \theta \cos \phi - (z_G W - z_B B) \sin \theta \\ - (I_x - I_z)rp + I_{xy}qr - (p^2 - r^2)I_{zx} - I_{yz}qp \\ - m[z_G(wq - vr) + x_G(uq - vp)] \\ + \frac{\rho}{2} C_d \int_{x_{tail}}^{x_{nose}} x d(x)(w - xq)\sqrt{(w - xq)^2 + (v + xr)^2} dx \end{aligned} \quad (7)$$

Yaw motion equation:

$$\begin{aligned}
& -m y_G \dot{u} + (m x_G - \frac{\rho}{2} l^4 N'_v) \dot{v} - (I_{zx} + \frac{\rho}{2} l^5 N'_p) \dot{p} - I_{yz} \dot{q} + (I_z - \frac{\rho}{2} l^5 N'_r) \dot{r} \\
& = \frac{\rho}{2} l^5 N'_{pq} pq + \frac{\rho}{2} l^4 [N'_p up + N'_r ur] \\
& + \frac{\rho}{2} l^3 [N'_{uu} u^2 + N'_{uv} uv + N'_{vvR} v \sqrt{v^2 + w^2}] \\
& + \frac{\rho}{2} l^3 N'_{\delta r} u^2 \delta r \\
& - (x_G W - x_B B) \cos \theta \sin \phi + (y_G W - y_B B) \sin \theta \\
& - (I_y - I_x) pq + I_{yz} rp - (q^2 - p^2) I_{xy} - I_{xz} rq \\
& + m [x_G (wp - ur) - y_G (vr - wq)] \\
& - \frac{\rho}{2} C_d \int_{x_{tail}}^{x_{nose}} x d(x) (v + xr) \sqrt{(w - xq)^2 + (v + xr)^2} dx
\end{aligned} \tag{8}$$

2.2 Simulink® Model

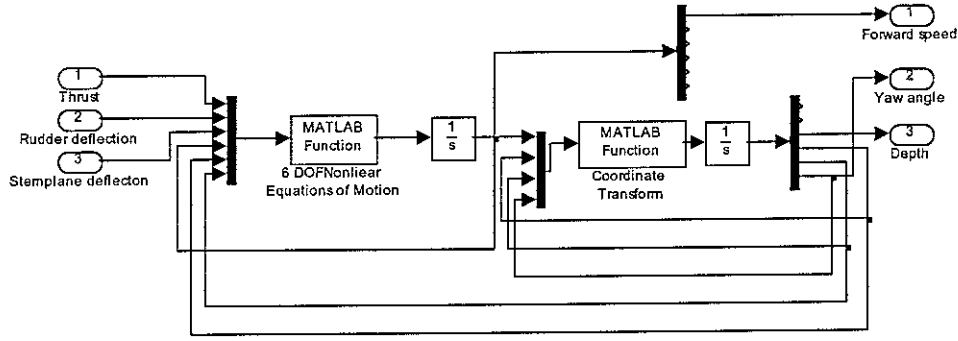

Full Nonlinear Model of Subzero II (without dynamics of actuators)
Designed by Z.Feng, University of Southampton

Fig 3 Subzero II Simulink model without actuators

The Simulink model has 3 control inputs: thrust, rudder deflection and sternplane deflection, and 3 outputs: forward speed u , yaw angle ψ and depth z .

The Simulink® model has two subsystems: 6 DOF Nonlinear Equations of Motion and Coordinate Transform. The former calls the Matlab function--motion.m, which calculates the motion acceleration of the vehicle according to the 6 DOF nonlinear motion equations of Subzero II as described in Section 2.1. The later calls the Matlab function – frame.m, which transforms motion speed from the vehicle-fixed frame to the earth-fixed frame, i.e.

$$\begin{bmatrix} \dot{x} \\ \dot{y} \\ \dot{z} \\ \dot{\phi} \\ \dot{\theta} \\ \dot{\psi} \end{bmatrix} = \begin{bmatrix} c_2 c_3 & -c_1 s_3 + s_1 s_2 c_3 & s_1 s_3 + c_1 s_2 c_3 & 0 & 0 & 0 \\ c_2 s_3 & c_1 c_3 + s_1 s_2 s_3 & -s_1 c_3 + c_1 s_2 s_3 & 0 & 0 & 0 \\ -s_2 & s_1 c_2 & c_1 c_2 & 0 & 0 & 0 \\ 0 & 0 & 0 & 1 & s_1 t_2 & c_1 t_2 \\ 0 & 0 & 0 & 0 & c_1 & -s_1 \\ 0 & 0 & 0 & 0 & \frac{s_1}{c_2} & \frac{c_1}{c_2} \end{bmatrix} \begin{bmatrix} u \\ v \\ w \\ p \\ q \\ r \end{bmatrix} \tag{9}$$

where

$$c_1 = \cos \phi, s_1 = \sin \phi, c_2 = \cos \theta, s_2 = \sin \theta, c_3 = \cos \psi, s_3 = \sin \psi, t_2 = \tan \theta$$

3 Thruster Model

3.1 Pulse width modulated (PWM) DC motor model

The DC motor has two inputs: control command M_d and the load torque (propeller torque) Q_{prop} , the output is the rotation speed n .

$$\begin{aligned}
 V_s &= 9.6(V) \\
 E &= 2\pi n k_\phi \\
 I_a &= \frac{M_d}{2500} \cdot \frac{\text{dead_zone}(V_s, V_b) - E}{R_a + R_f} \\
 \dot{n} &= \frac{1}{2\pi J_T} \left\{ \text{dead_zone}\left[k_\phi \cdot \text{dead_zone}\left(I_a, \frac{0.01V_s}{R_a + R_f}\right), 0.001|n|\right] - Q_{prop} \right\}
 \end{aligned} \tag{10}$$

where

$$\begin{aligned}
 k_\phi &= 0.0374 - 3.88 \times 10^{-4}|n| + 2.02 \times 10^{-5}n^2 - 5.63 \times 10^{-7}|n|^3 + 1.20 \times 10^{-8}n^4 \\
 R_a &= 0.223(\Omega), R_f = 1.577(\Omega), L_a = 74(\mu H), J_T = 1.65(\text{kg}\cdot\text{m}^2)
 \end{aligned}$$

and

$$\text{dead_zone}(a, b) = \begin{cases} 0, & |a| \leq b \\ a - b & a > b \\ a + b & a < -b \end{cases}$$

The Simulink model is as shown in Fig 4.

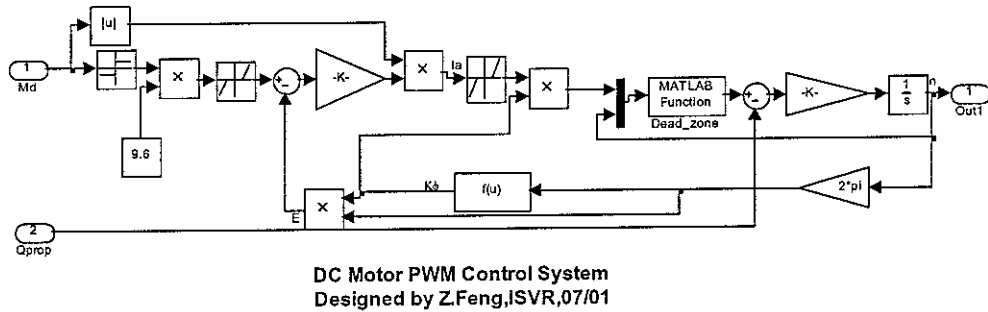

Fig 4 DC Motor

3.2 Propeller Model

The propeller has two inputs: the rotation speed n and the flow speed u , and has two outputs: thrust T and torque Q_{prop} .

$$\beta = a \tan 2(u, 0.7\pi mD) \text{ (Advance angle)}$$

$$T = \frac{1}{8} \pi \rho D^2 C_t [u^2 + (0.7\pi mD)^2] \quad (11)$$

$$Q_{prop} = \frac{1}{8} \pi \rho D^3 C_q [u^2 + (0.7\pi mD)^2]$$

where C_t, C_q are the thrust and torque coefficient, and

$$C_t = \frac{a_{t0}}{2} + \sum_{i=1}^{20} [a_{ti} \cos(i\beta) + b_{ti} \sin(i\beta)]$$

$$C_q = \frac{a_{q0}}{2} + \sum_{i=1}^{20} [a_{qi} \cos(i\beta) + b_{qi} \sin(i\beta)] \quad (12)$$

Fig 5 shows the relationship between the thrust and torque coefficients and the advance angle.

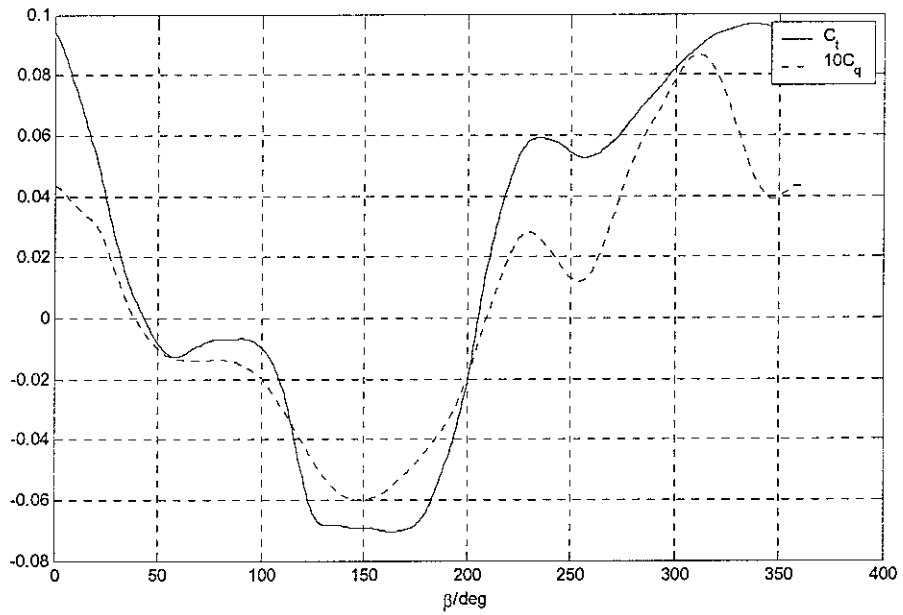

Fig 5 Thrust and torque coefficient

3.3 Thruster model

By connecting the DC motor model with the propeller model, the thruster model is established as shown in Fig 6. The model has two inputs: DC motor control command and the vehicle's forward speed. The output of the model is the thrust. The model calls two Matlab functions—Ct.m and Cq.m, which calculates the thrust and torque coefficients respectively.

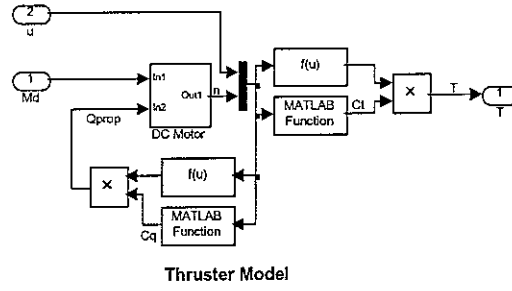

Fig 6 Thruster model

4 Rudder and Sternplane Actuator Models

Rudders and Sternplane are driven by two DC motors respectively. Their dynamics can be modelled as the following transfer functions:

$$\delta r(s) = \frac{6.921}{s + 7.69} \delta r_d(s) \quad (13)$$

$$\delta s(s) = \frac{10.377}{s + 11.53} \delta s_d(s) \quad (14)$$

where $\delta r, \delta s$ are the actual rudder and stern plane deflections, while $\delta r_d, \delta s_d$ are the desired rudder and stern plane deflections.

5 Full Nonlinear Model of Subzero II

5.1 Simulink® Model

By connecting the thruster, rudder and sternplane actuator dynamic models to the nonlinear equations of motion, the full nonlinear model of Subzero II is established as shown in Fig 7. The model has 3 control inputs: DC motor control command M_d , desired rudder deflection δr_d and desired sternplane deflection δs_d , and 3 outputs: forward speed u , yaw angle ψ and depth z . The limitations of the actuators are also considered in the model: $-2100 \leq M_d \leq 2100$, $-20^\circ \leq \delta r \leq 20^\circ$, and $-30^\circ \leq \delta s \leq 30^\circ$.

Subzeroll Nonlinear Simulation with Actuators
 Designed by Z.Feng,ISVR,07/01

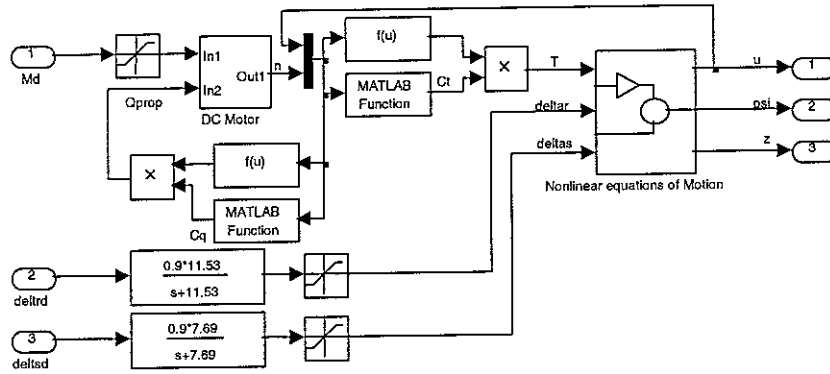

Fig 7 Full nonlinear model of Subzero II

5.2 Simulation Results

Suppose the vehicle is at rest.

(1) Forward acceleration

The motor control command increases at a ramp of 52.2/s, and holds at 522 after 10s. The vehicle will accelerate from 0m/s to 1.3m/s and then retain the constant speed of 1.3m/s. However, the depth also changes while the vehicle accelerates. The simulation results are shown in Fig 8.

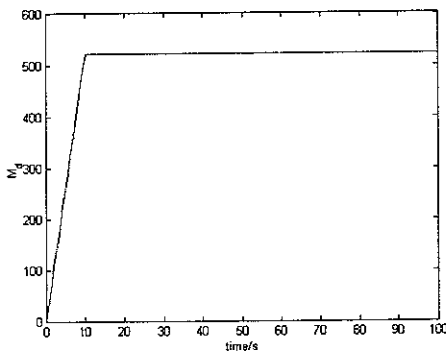

(a) Motor control command

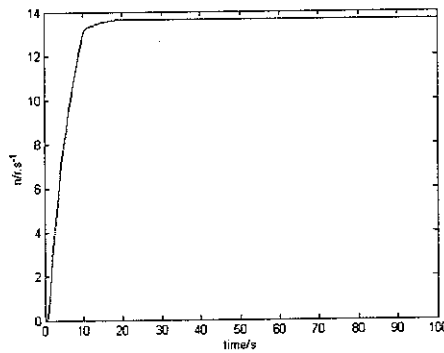

(b) Propeller rotation speed

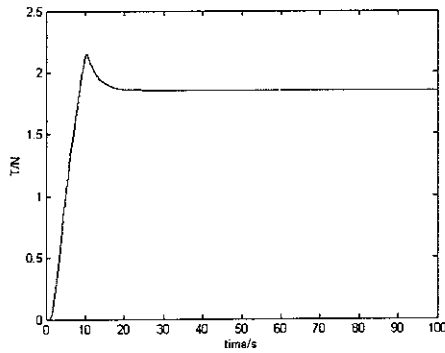

(c) Thrust

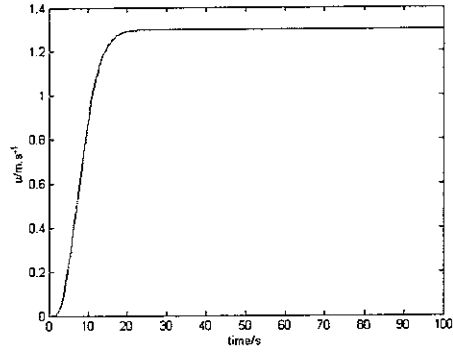

(d) Forward speed

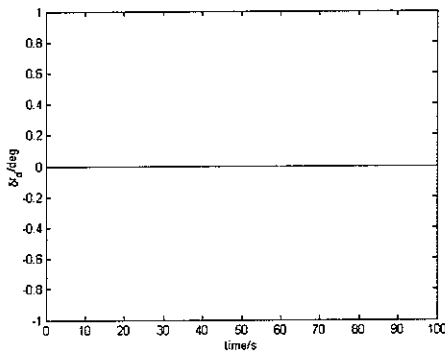

(e) Rudder command

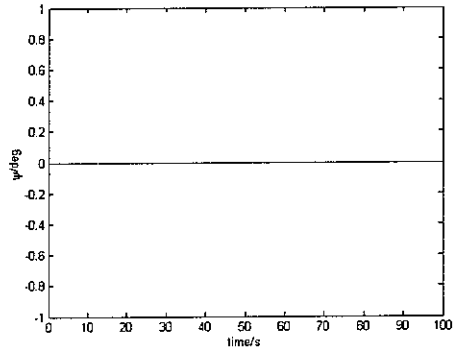

(f) Yaw angle

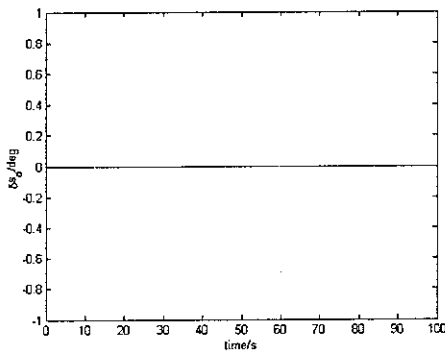

(g) Sternplane command

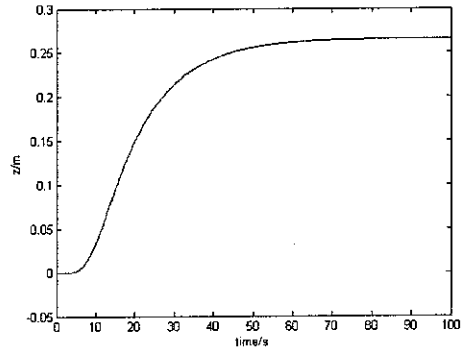

(f) Depth

Fig 8 Vehicle acceleration

(2) Steering

The DC motor control command increases at a ramp of 52.2/s, and holds at 522 after 10s. The vehicle will accelerate from 0m/s to 1.3m/s and then retain the constant speed of 1.3m/s. Then the rudder command steps from 0° to 5° at 50s and steps from 5° to 0° at 54s, the simulation results are shown in Fig 9.

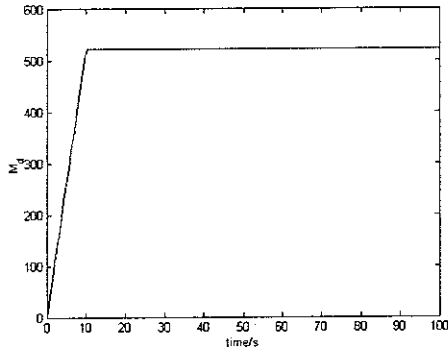

(a) Motor control command

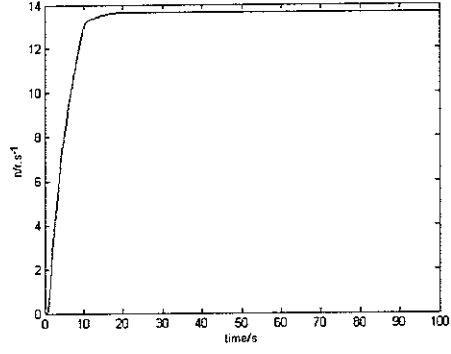

(b) Propeller rotation speed

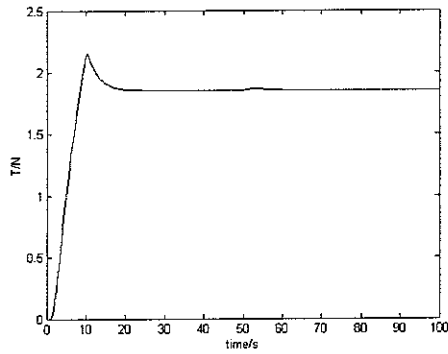

(c) Thrust

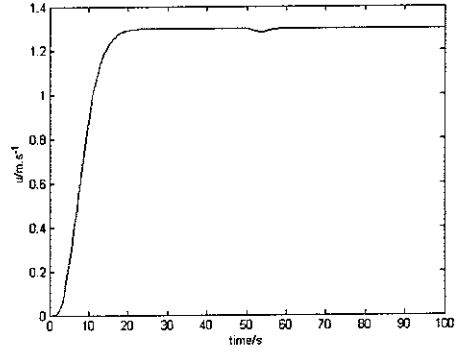

(d) Forward speed

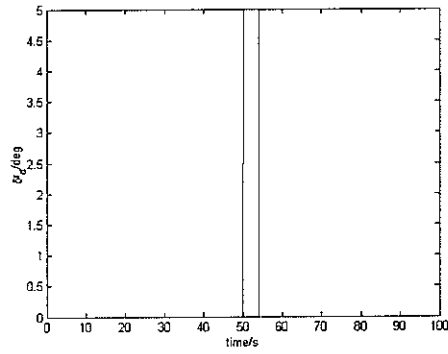

(e) Rudder command

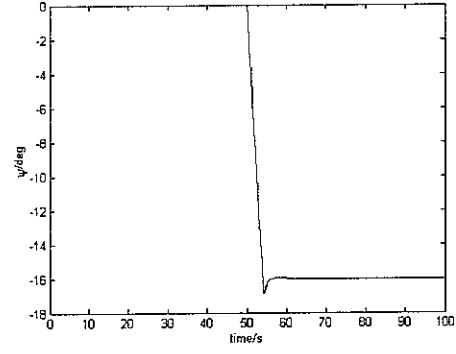

(f) Yaw angle

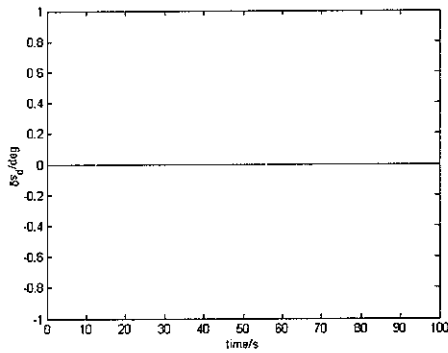

(g) Sternplane command

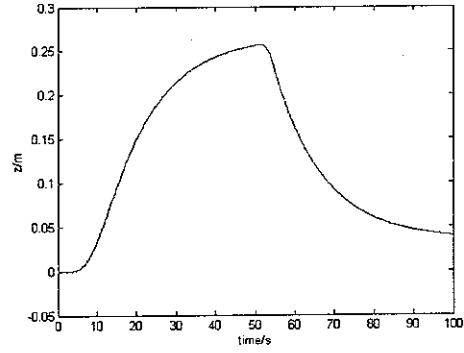

(f) Depth

Fig 9 Vehicle steering

(3) Diving

The motor control command increases at a ramp of 52.2/s, and holds at 522 after 10s. The vehicle will accelerate from 0m/s to 1.3m/s and then retain the constant speed of 1.3m/s. Then the sternplane command steps from 0° to 2° at 50s and steps from 2° to 0° at 52s, the simulation results are shown in Fig 10.

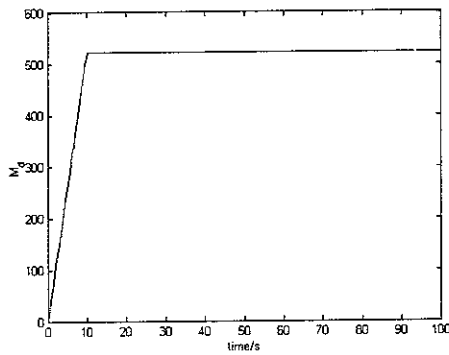

(a) Motor control command

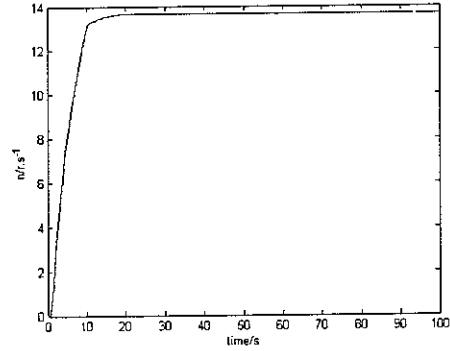

(b) Propeller rotation speed

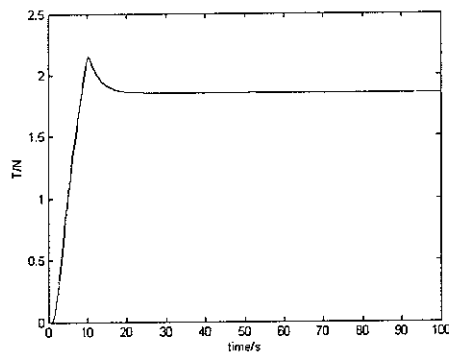

(c) Thrust

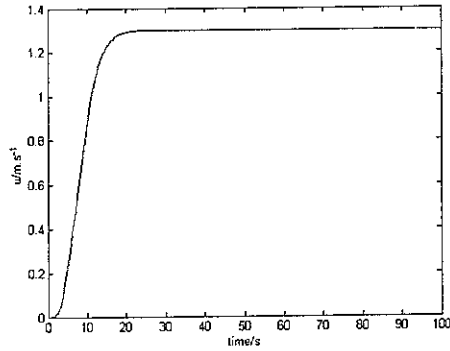

(d) Forward speed

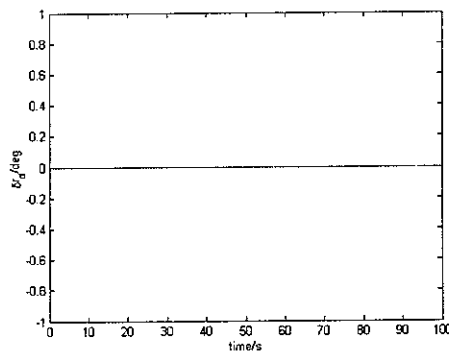

(e) Rudder command

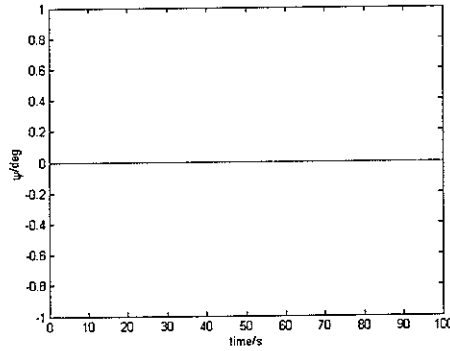

(f) Yaw angle

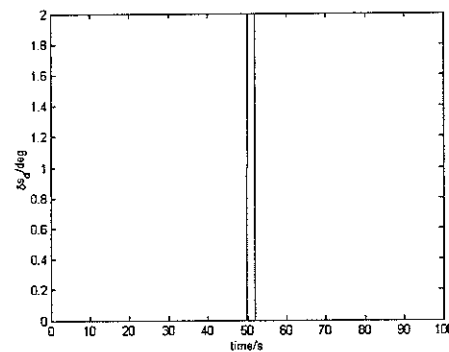

(g) Sternplane command

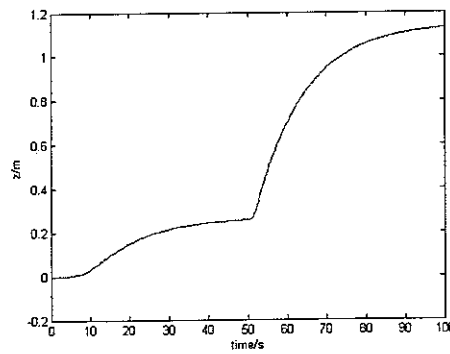

(f) Depth

Fig 10 Vehicle diving

6 Linearized model

6.1 Linearized model

When designing a linear controller for the vehicle, e.g. an H_∞ autopilot, it is often necessary to establish linearized models around representative operating points. The linearized model is extracted from the full nonlinear model of the vehicle. For Subzero II, the nonlinear model is composed of the nonlinear equations of motion (Eqs.3-8) and the actuator models (Eqs.10-14). We write the nonlinear model in a state-space form

$$\begin{aligned}\dot{x} &= f(x, u) \\ y &= h(x, u)\end{aligned}\quad (15)$$

where x , u and y denote states, control inputs and outputs, respectively, and

$$\begin{aligned}x &= [u \ v \ w \ p \ q \ r \ x \ y \ z \ \phi \ \theta \ \psi \ n \ \delta r \ \delta s]^T \\ u &= [M_d \ \delta r_d \ \delta s_d]^T \\ y &= [u \ \psi \ z]^T\end{aligned}$$

By linearizing the nonlinear model (15) around a steady operating point (x_0, u_0) , a linearized state-space model can be obtained

$$\begin{aligned}\Delta \dot{x} &= \mathbf{A} \Delta x + \mathbf{B} \Delta u \\ \Delta y &= \mathbf{C} \Delta x + \mathbf{D} \Delta u\end{aligned}\quad (16)$$

where

$$\Delta x = x - x_0, \quad \Delta u = u - u_0, \quad \Delta y = y - y_0 = h(x, u) - h(x_0, u_0)$$

and

$$\mathbf{A} = \left. \frac{\partial f}{\partial x} \right|_{(x_0, u_0)}, \quad \mathbf{B} = \left. \frac{\partial f}{\partial u} \right|_{(x_0, u_0)}, \quad \mathbf{C} = \left. \frac{\partial h}{\partial x} \right|_{(x_0, u_0)}, \quad \mathbf{D} = \left. \frac{\partial h}{\partial u} \right|_{(x_0, u_0)}$$

Once a linearized state-space has been established, the transfer function can be obtained directly from (16), i.e.

$$\Delta Y(s) = G(s) \cdot \Delta U(s) \quad (17)$$

where $G(s) = \mathbf{C}(s\mathbf{I} - \mathbf{A})^{-1}\mathbf{B} + \mathbf{D}$ (18)

6.2 A linearized model of Subzero II

Around a representative operating point of (x_0, u_0) as

$$\begin{aligned}x_0 &= [u_0 \ v_0 \ w_0 \ p_0 \ q_0 \ r_0 \ x_0 \ y_0 \ z_0 \ \phi_0 \ \theta_0 \ \psi_0 \ n_0 \ \delta r_0 \ \delta s_0]^T \\ &= [1.3009 \ 0 \ 0 \ 0 \ 0 \ 0 \ 0 \ 0 \ 0 \ 0 \ 0 \ 0 \ 0 \ 13.6722 \ 0 \ 0]^T \\ u_0 &= [M_{d0} \ \delta r_{d0} \ \delta s_{d0}]^T = [522 \ 0 \ 0]^T\end{aligned}$$

the linearized state-space model is established, the dynamic matrices $ABCD$ are as follows:

A

-0.5558	0.0000	0.0474	0.0000	0.0516	0.0000	0.0000	0.0000	0.0000	0.0000	0.0038	0.0000	0.0582	0.0000	0.8272
0.0000	-2.1336	0.0000	-0.0780	0.0000	0.3200	0.0000	0.0000	0.0000	0.0000	0.0000	0.0000	0.0000	0.0000	12.4627
0.0010	0.0000	-2.1258	0.0000	-0.3734	0.0000	0.0000	0.0000	0.0000	0.0000	-0.0175	0.0000	-0.0001	0.0000	-18.8972
0.0000	-2.4947	0.0000	-24.6893	0.0000	-16.8760	0.0000	0.0000	0.0000	0.0000	0.0000	0.0000	0.0000	0.0000	-44.2841
0.0365	0.0000	-7.9967	0.0000	-8.7065	0.0000	0.0000	0.0000	0.0000	0.0000	-0.6474	0.0000	-0.0038	0.0000	-139.5066
0.0000	7.9629	0.0000	-0.3036	0.0000	-8.9107	0.0000	0.0000	0.0000	0.0000	0.0000	0.0000	0.0000	0.0000	-93.5532
1.0000	0.0000	0.0000	0.0000	0.0000	0.0000	0.0000	0.0000	0.0000	0.0000	0.0000	0.0000	0.0000	0.0000	0.0000
0.0000	1.0000	0.0000	0.0000	0.0000	0.0000	0.0000	0.0000	0.0000	0.0000	0.0000	0.0000	1.3009	0.0000	0.0000
0.0000	0.0000	1.0000	0.0000	0.0000	0.0000	0.0000	0.0000	0.0000	0.0000	0.0000	0.0000	-1.3009	0.0000	0.0000
0.0000	0.0000	0.0000	1.0000	0.0000	0.0000	0.0000	0.0000	0.0000	0.0000	0.0000	0.0000	0.0000	0.0000	0.0000
0.0000	0.0000	0.0000	0.0000	1.0000	0.0000	0.0000	0.0000	0.0000	0.0000	0.0000	0.0000	0.0000	0.0000	0.0000
0.0000	0.0000	0.0000	0.0000	0.0000	1.0000	0.0000	0.0000	0.0000	0.0000	0.0000	0.0000	0.0000	0.0000	0.0000
7.2126	0.0000	0.0000	0.0000	0.0000	0.0000	0.0000	0.0000	0.0000	0.0000	0.0000	0.0000	0.0000	-4.0814	0.0000
0.0000	0.0000	0.0000	0.0000	0.0000	0.0000	0.0000	0.0000	0.0000	0.0000	0.0000	0.0000	0.0000	0.0000	-7.6900
0.0000	0.0000	0.0000	0.0000	0.0000	0.0000	0.0000	0.0000	0.0000	0.0000	0.0000	0.0000	0.0000	0.0000	-11.5300

B

0.0000	0.0000	0.0000
0.0000	0.0000	0.0000
0.0000	0.0000	0.0000
0.0000	0.0000	0.0000
0.0000	0.0000	0.0000
0.0000	0.0000	0.0000
0.0000	0.0000	0.0000
0.0000	0.0000	0.0000
0.0000	0.0000	0.0000
0.0000	0.0000	0.0000
0.0000	0.0000	0.0000
0.0492	0.0000	0.0000
0.0000	1.0000	0.0000
0.0000	0.0000	1.0000

C

1.0000	0.0000	0.0000	0.0000	0.0000	0.0000	0.0000	0.0000	0.0000	0.0000	0.0000	0.0000	0.0000	0.0000	0.0000
0.0000	0.0000	0.0000	0.0000	0.0000	0.0000	0.0000	0.0000	0.0000	0.0000	0.0000	1.0000	0.0000	0.0000	0.0000
0.0000	0.0000	0.0000	0.0000	0.0000	0.0000	0.0000	0.0000	1.0000	0.0000	0.0000	0.0000	0.0000	0.0000	0.0000

D

0.0000	0.0000	0.0000
0.0000	0.0000	0.0000
0.0000	0.0000	0.0000

From the linearized state-space model, the transfer function matrix can be obtained

$$G(s) = \begin{bmatrix} g_{11}(s) & g_{12}(s) & g_{13}(s) \\ g_{21}(s) & g_{22}(s) & g_{23}(s) \\ g_{31}(s) & g_{32}(s) & g_{33}(s) \end{bmatrix}$$

where

$$g_{11}(s) = \frac{0.002864 s^3 + 0.03101 s^2 + 0.04628 s + 0.00354}{s^5 + 15.47 s^4 + 68.25 s^3 + 96.23 s^2 + 35.61 s + 2.285}$$

$$g_{12}(s) = 0$$

$$g_{13}(s) = \frac{0.8272 s^4 + 4.239 s^3 + 3.52 s^2 + 5.664 e^{-14} s + 5.205 e^{-15}}{s^6 + 27 s^5 + 246.6 s^4 + 883.1 s^3 + 1145 s^2 + 412.9 s + 26.35}$$

$$g_{21}(s) = 0$$

$$g_{22}(s) = \frac{-93.55 s^2 - 2397 s - 2394}{s^5 + 43.42 s^4 + 558.6 s^3 + 2566 s^2 + 2946 s}$$

$$g_{23}(s) = 0$$

$$g_{31}(s) = \frac{-5.07 e^{-006} s^3 + 0.0002706 s^2 + 0.0004672 s + 1.841 e^{-018}}{s^6 + 15.47 s^5 + 68.25 s^4 + 96.23 s^3 + 35.61 s^2 + 2.285 s}$$

$$g_{32}(s) = 0$$

$$g_{33}(s) = \frac{-18.9s^4 - 18.58s^3 + 464.7s^2 + 959.5s + 331.5}{s^7 + 27s^6 + 246.6s^5 + 883.1s^4 + 1145s^3 + 412.9s^2 + 26.35s}$$

It is necessary to verify the linearized model established. The direct way of verification is to compare the responses of the linearized model and the nonlinear model from which the linearized model is extracted under the same small perturbations of the control inputs. The comparison of the responses under small perturbations of control inputs is shown in Figs 11-13. In Fig 11, the DC motor control command is perturbed by +52.2 (+10%) while the desired rudder and sternplane deflections remain unchanged. In Fig 12, the desired rudder deflection is perturbed by +5° at 1s and -5° at 5s. In Fig 13, the desired sternplane deflection is perturbed by +5° at 1s and -5° at 5s. From a comparison of responses, we can conclude that the linearized model is reliable.

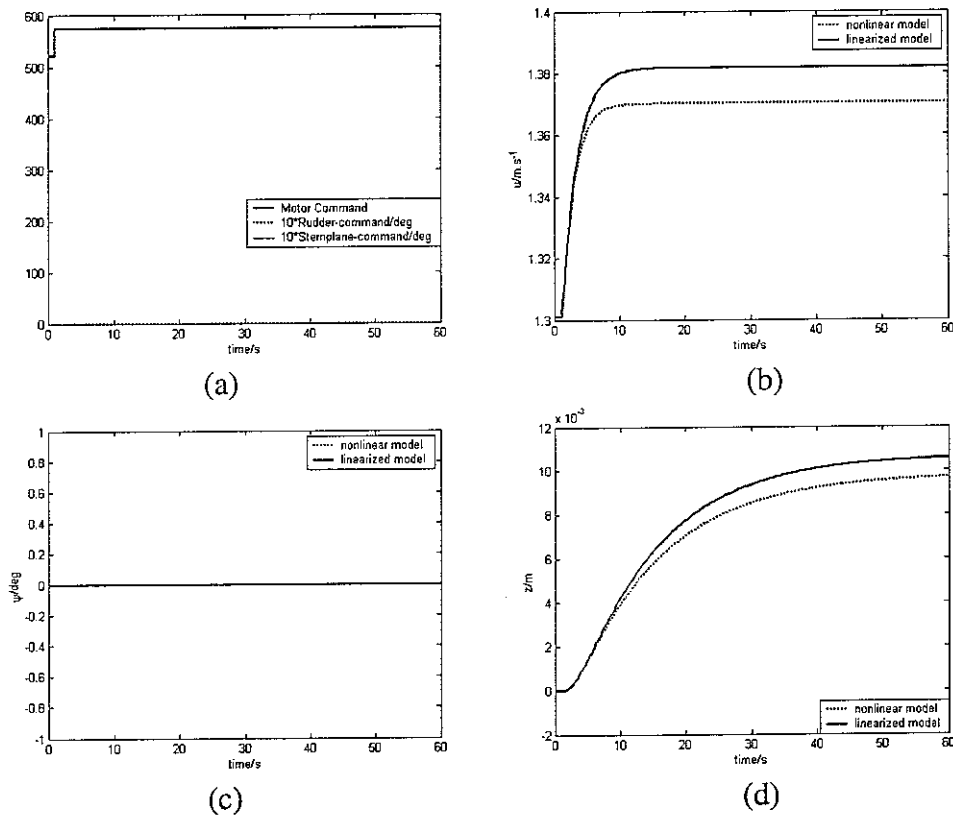
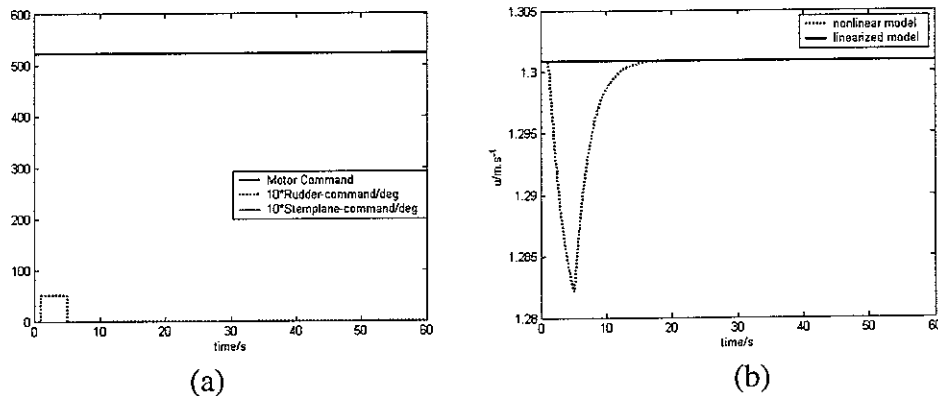

Fig 11 Comparison of response under the DC motor control command perturbation (a)-control inputs,(b)-forward speed,(c)-yaw angle, (d)-depth



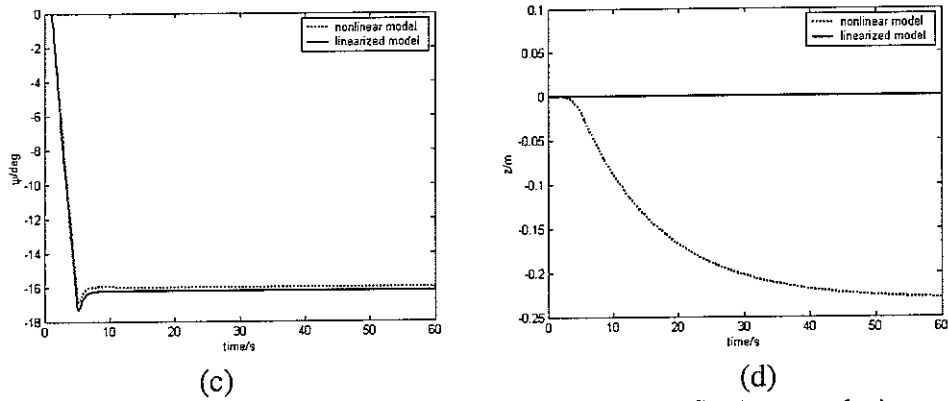

Fig 12 Comparison of response under the desired rudder deflection perturbation
(a)-control inputs,(b)-forward speed,(c)-yaw angle, (d)-depth

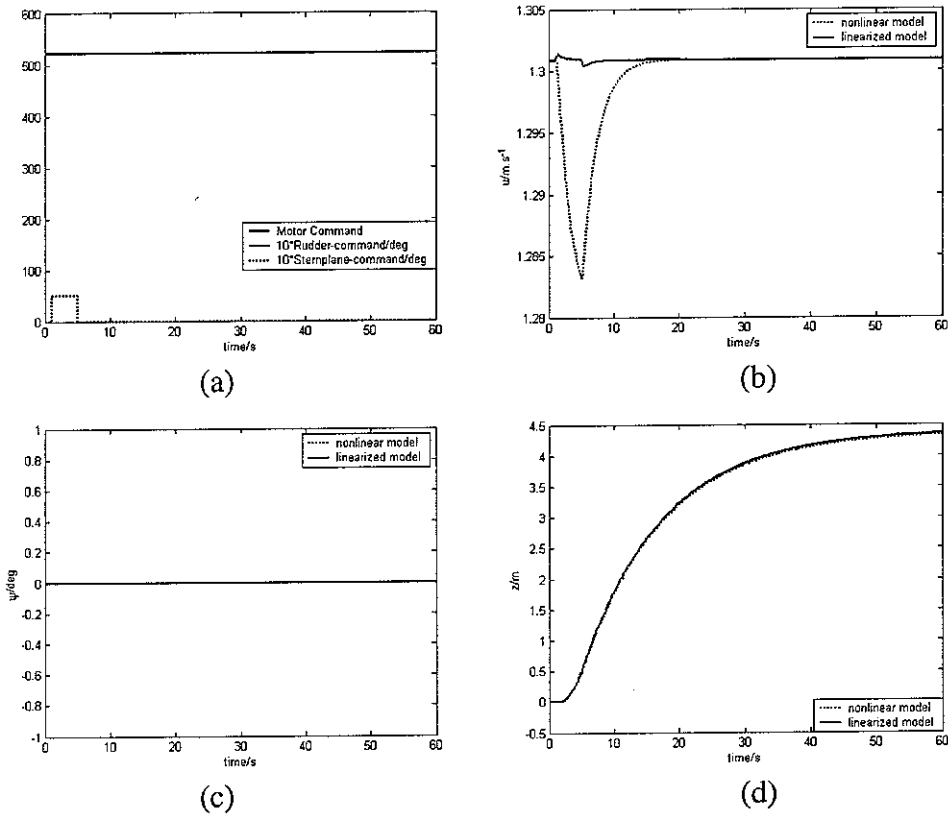

Fig 13 Comparison of response under desired sternplane deflection perturbation
(a)-control inputs,(b)-forward speed,(c)-yaw angle, (d)-depth

7 Summary

This report summarizes the research work of the first stage in the IMPROVES project completed by the University of Southampton. The full nonlinear model and the linearized models around several representative operating points have been established. It should be noted that the accuracy of both nonlinear and linearized models can be improved via further detailed tank tests to measure the hydrodynamic derivatives. However model uncertainty will be unavoidable.

The future research work will be the design of an H_∞ autopilot for Subzero II and modelling of Seaeye ROV dynamics.

References

1. A.R.Dawson, M.J. Downer, G. Patterson, P.Pattni, and D.J. Warrender, "SUBZERO: A low cost remotely operated underwater vehicle", Group design report, Faculty of Engineering and Applied Science, University of Southampton, May 1992.
2. R.Lea, R.Allen, and S.Merry, "A low-cost remotely operated underwater vehicle", *Journal of Measurement + Control*, Vol.29, Sept. 1996.
3. R.Lea, "AutoRov—an underwater flight vehicle simulation program", Tech. Memo. 828, ISVR, University of Southampton, July 1998.
4. R.Lea, "A Comparative Study by Simulation and Experimentation of Control Techniques for Autonomous Underwater Flight Vehicles", PhD Thesis, ISVR, University of Southampton, 1998.
5. J.Feldman, "Revised standard submarine equations of motion", Tech. Rep. SPD-0393-09, David W Taylor Naval Ship Research and Development Center, 1979.